

08.01.2019		1.03	
08.08.2018	Edenhofer	1.00	Anschlussbelegung & Schaltplan
Datum	Gezeichnet	Ver.	Bemerkung
Maßstab	Kompressor Fernschalter		Blatt 1/5

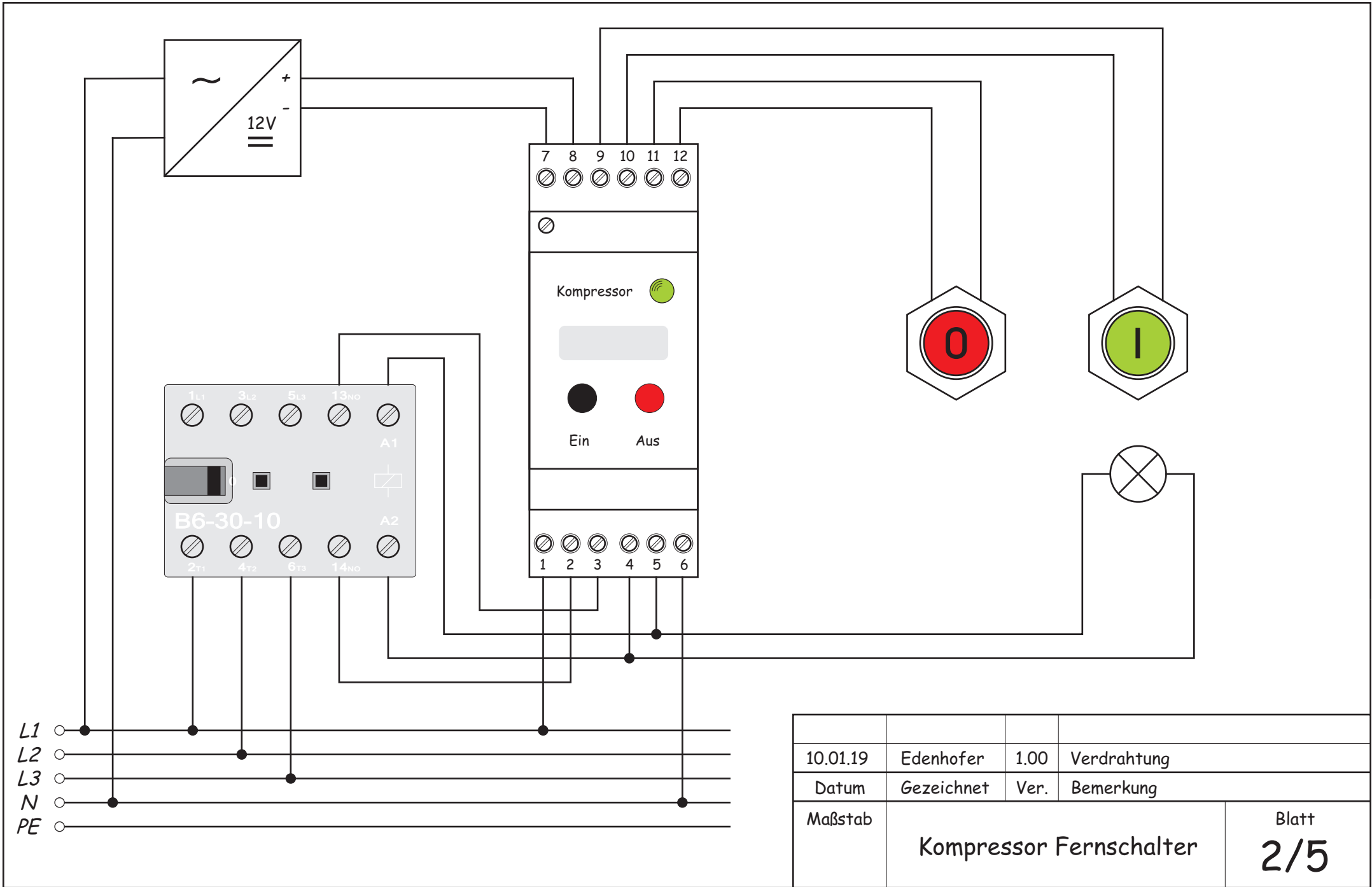

10.01.19	Edenhofer	1.00	Verdrahtung
Datum	Gezeichnet	Ver.	Bemerkung
Maßstab	Kompressor Fernschalter		Blatt 2/5

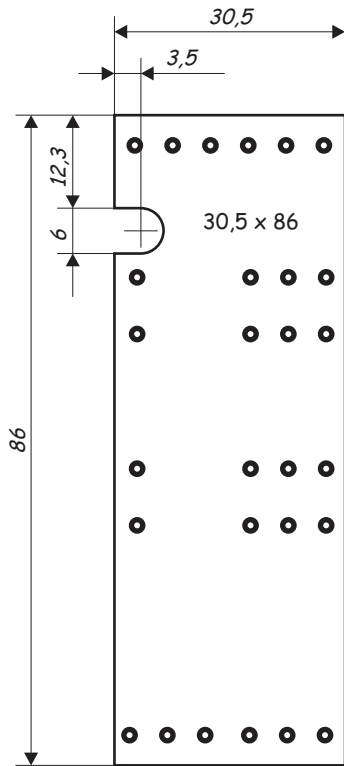

Bestückungsseite

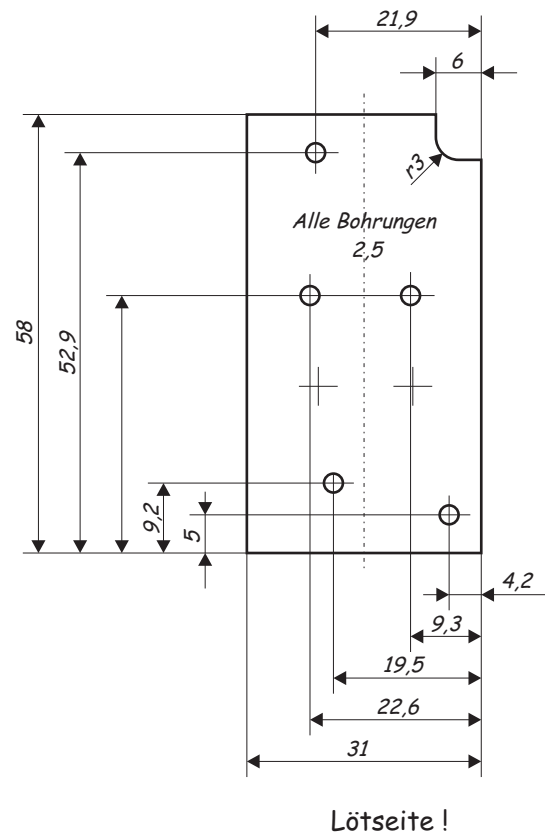

Lötseite !

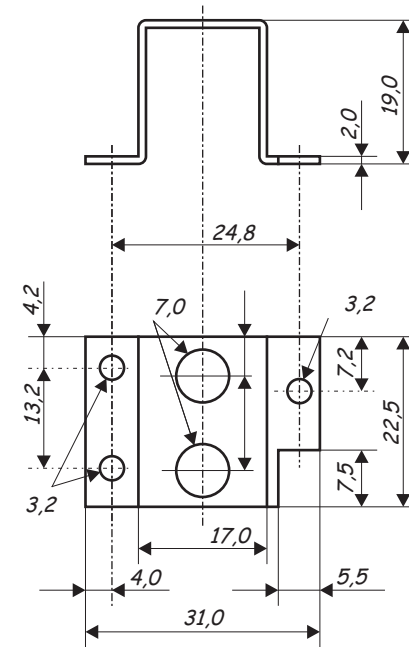

05.01.2019	Edenhofer	1.01	Leiterplatten, mechanisch, Haltebügel
Datum	Gezeichnet	Ver.	Bemerkung
Maßstab	Kompressor Fernschalter		Blatt
1:1			3/5

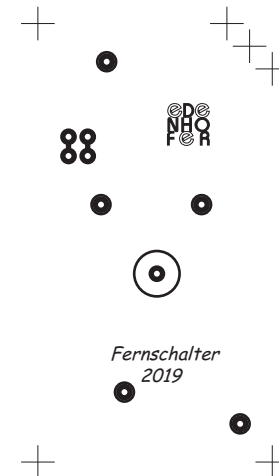
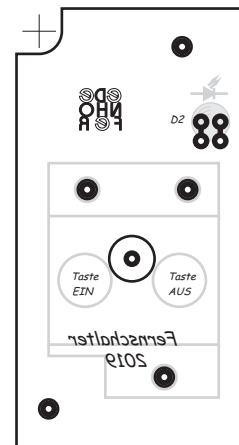
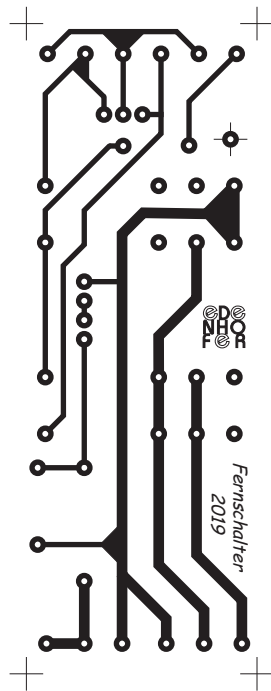
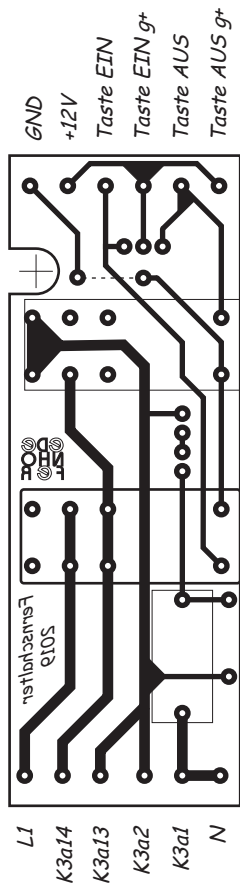
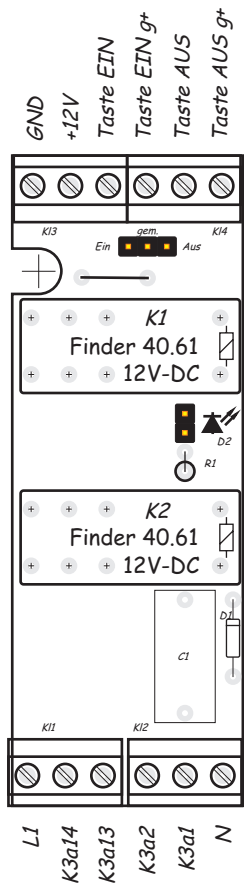

08.01.19	Edenhofer	1.00	Bestückung & Layout
Datum	Gezeichnet	Ver.	Bemerkung
Maßstab	Kompressor Fernschalter		Blatt
1:1			4/5

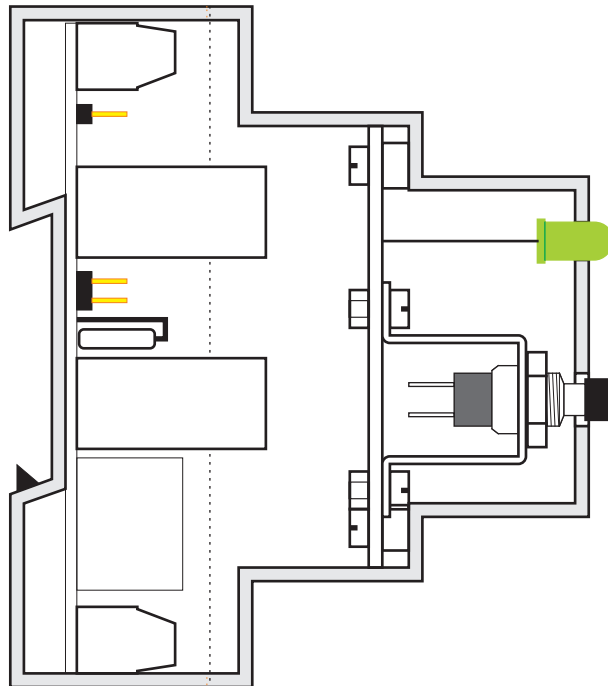
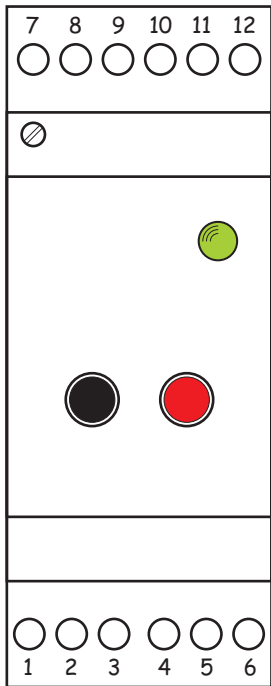

Printpl.		2	Nach Zeichnung
Bügel		1	Nach Zeichnung
Klemme	3P-Klemme	4	450857
Taster	Einbautaster	2	420322
Stecker	Pfostenst.	2	2pol. Und 3pol., RM2.54
R1	10 Ohm	1	
C1	330nF/400V	1	RM15,24
D2	LED gn 5mm	1	
D1	Zd. 2V7/1W	1	
Relais	Finder 40.61	2	
Gehäuse	Hutschg. 2C	1	460145
Teil	Bezeichnung	Stk.	Best. Nr. Pollin
10.01.19	Edenhofer	1.00	Zusammenbau, Stückliste
Datum	Gezeichnet	Ver.	Bemerkung
Maßstab	1:1		Blatt
	Kompressor Fernschalter		5/5